

### 4S1 & 4SS-Series

Sub-Miniature &  
**Sealed** Sub-Miniature  
Slide Switches

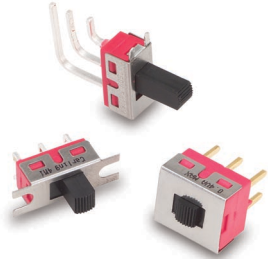

### 4M1-Series

Miniature Slide Switch

### Specifications

Contact Rating . . . . . refer to ordering scheme  
 Electrical Life . . . . . 30,000 make & break cycles at full load  
 Contact Resistance. . . . . 10 mΩ max. initial @ 2-4 VDC  
 100mA for both silver & gold plated contacts.  
 Insulation Resistance . . . . 1000 MΩ min.  
 Dielectric Strength . . . . . 1500 Volts RMS @ sea level  
 Operating Temperature . . . -30°C to +85°C  
 Solder Heat Resistance. . . MIL-STD-202, Method 210  
 Actuator Travel . . . . . 25°

### Materials

Case . . . . . Diallyl phthalate (DAP) (UL 94V-0)  
 Slide Handle. . . . . Nylon  
 Housing. . . . . Stainless Steel  
 Terminal Seal . . . . . Epoxy

### 4S1-Series Ordering Scheme



<b>1 SERIES</b> <b>4S1</b> Sub-Miniature Slide Switch																
<b>2 POLES</b> <b>FSP</b> single pole																
<b>3 CIRCUIT</b> <table style="width: 100%; border-collapse: collapse;"> <tr> <td colspan="4" style="text-align: center;"><b>Switching Position:</b></td> </tr> <tr> <td style="width: 10%;"></td> <td style="width: 15%;">2-1</td> <td style="width: 20%;">OPEN</td> <td style="width: 15%;">2-3</td> </tr> <tr> <td style="text-align: center;"><b>1</b></td> <td>ON</td> <td>NONE</td> <td>ON</td> </tr> <tr> <td style="text-align: center;"><b>3</b></td> <td>ON</td> <td>OFF</td> <td>ON</td> </tr> </table>	<b>Switching Position:</b>					2-1	OPEN	2-3	<b>1</b>	ON	NONE	ON	<b>3</b>	ON	OFF	ON
<b>Switching Position:</b>																
	2-1	OPEN	2-3													
<b>1</b>	ON	NONE	ON													
<b>3</b>	ON	OFF	ON													
<b>4 TERMINATION</b> <b>M2</b> PCB <b>M6</b> PC Mount, 90° horizontal																

<b>5 CONTACT</b>		
<b>G</b>	silver <sup>1</sup> gold over silver <sup>3</sup>	Rating 3A@125VAC or 28VDC; 1.5A @ 250VAC
<b>K</b>	gold <sup>2</sup> tin-lead <sup>4</sup>	0.4VA max. @20V max (AC/DC)
<b>P</b>	silver <sup>1</sup> tin-lead <sup>4</sup>	3A@125VAC or 28VDC; 1.5A @ 250VAC
<b>Q</b>	silver <sup>1</sup> silver <sup>1</sup>	3A@125VAC or 28VDC; 1.5A @ 250VAC
<b>R</b>	gold <sup>2</sup> gold <sup>2</sup>	0.4VA max. @20V max (AC/DC)
NOTE: Tin-lead option available with PC type terminations only. 1 Moveable contact & terminals: copper alloy, silver plate 2 Moveable contact & terminals: copper alloy with gold plate over nickel plate 3 Terminals: silver plate with outer layer in gold plating		
<b>6 EPOXY SEAL</b> <b>E</b> epoxy seal		
<b>7 PACKAGING</b> Switches are bulk packed, unless T/R is specified at the end of the part number. <b>T/R</b> tape reel - 500 pieces per reel		

## 4SS-Series Ordering Scheme



<b>1 SERIES</b> <b>4SS</b> Sealed Sub-Miniature Slide Switch															
<b>2 POLES</b> <b>FSP</b> single pole															
<b>3 CIRCUIT</b> <b>Switching Position:</b> <table style="width: 100%; border-collapse: collapse;"> <tr> <td style="width: 10%;"></td> <td style="width: 10%;"></td> <td style="width: 10%; text-align: center;"><i>OPEN</i></td> <td style="width: 10%;"></td> <td style="width: 10%; text-align: center;"><i>2-3</i></td> </tr> <tr> <td style="text-align: center;"><b>1</b></td> <td style="text-align: center;">ON</td> <td style="text-align: center;">NONE</td> <td></td> <td style="text-align: center;">ON</td> </tr> <tr> <td style="text-align: center;"><b>3</b></td> <td style="text-align: center;">ON</td> <td style="text-align: center;">OFF</td> <td></td> <td style="text-align: center;">ON</td> </tr> </table>			<i>OPEN</i>		<i>2-3</i>	<b>1</b>	ON	NONE		ON	<b>3</b>	ON	OFF		ON
		<i>OPEN</i>		<i>2-3</i>											
<b>1</b>	ON	NONE		ON											
<b>3</b>	ON	OFF		ON											
<b>4 TERMINATION</b> <b>Termination options for switches with brick color actuators</b> <b>M2</b> PCB <b>M6</b> PC Mount, 90° horizontal <b>M7</b> PC Mount, 90° vertical <b>Termination options for switches with white color actuators</b> <b>L6</b> Surface Mount, 90° flat <b>S6</b> Surface Mount, 90° horizontal <b>S7</b> Surface Mount, 90° vertical															

<b>5 CONTACT</b>			
	<i>Material</i>	<i>Terminal Plating</i>	<i>Rating</i>
<b>G</b>	silver <sup>1</sup>	gold over silver	3A@125VAC or 28VDC; 1.5A @ 250VAC
<b>K</b>	gold <sup>2</sup>	tin-lead <sup>4</sup>	0.4VA max. @20V max (AC/DC)
<b>P</b>	silver <sup>1</sup>	tin-lead	3A@125VAC or 28VDC; 1.5A @ 250VAC
<b>R</b>	gold <sup>2</sup>	gold <sup>2</sup>	0.4VA max. @20V max (AC/DC)
NOTE:			
Tin-lead option available with PC type terminations only.			
1 Moveable contact & terminals: copper alloy, silver plate			
2 Moveable contact & terminals: copper alloy with gold plate over nickel plate			
3 Terminals: silver plate with outer layer in gold plating			
4 Outer terminals: copper alloy with tin-lead over nickel plate			

<b>6 EPOXY SEAL</b>
<b>E</b> epoxy seal

<b>7 PACKAGING</b>
Switches are bulk packed, unless <b>T/R</b> is specified at the end of the part number.
<b>T/R</b> tape reel - 500 pieces per reel

## 4M1-Series Ordering Scheme

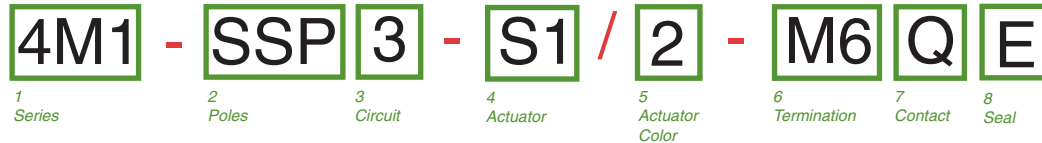

<b>1 SERIES</b> <b>4M1</b> Miniature Slide Switch															
<b>2 POLES</b> <b>SSP</b> single pole <span style="float: right;"><b>SDP</b> double pole</span>															
<b>3 CIRCUIT</b> <b>Switching Position</b> <table style="width: 100%; border-collapse: collapse;"> <tr> <td style="width: 10%;"></td> <td style="width: 10%;"></td> <td style="width: 10%; text-align: center;"><i>OPEN</i></td> <td style="width: 10%;"></td> <td style="width: 10%; text-align: center;"><i>2-3, 5-6</i></td> </tr> <tr> <td style="text-align: center;"><b>1</b></td> <td style="text-align: center;">ON</td> <td style="text-align: center;">NONE</td> <td></td> <td style="text-align: center;">ON</td> </tr> <tr> <td style="text-align: center;"><b>3</b></td> <td style="text-align: center;">ON</td> <td style="text-align: center;">OFF</td> <td></td> <td style="text-align: center;">ON</td> </tr> </table>			<i>OPEN</i>		<i>2-3, 5-6</i>	<b>1</b>	ON	NONE		ON	<b>3</b>	ON	OFF		ON
		<i>OPEN</i>		<i>2-3, 5-6</i>											
<b>1</b>	ON	NONE		ON											
<b>3</b>	ON	OFF		ON											
<b>4 ACTUATOR</b> <b>S1</b> .201 [5.10] high <b>S2</b> .285 [7.25] high <b>S3</b> .370 [9.40] high <b>S4</b> .140 [3.55] high <b>S5</b> .053 [1.35] high (for DPDT only) <b>S6</b> .482 [12.25] high <b>S7</b> .311 [7.90] high <b>T1</b> .201 [5.10] high (for DPDT only)															
<b>5 ACTUATOR COLOR<sup>1</sup></b> <table style="width: 100%; border-collapse: collapse;"> <tr> <td style="width: 15%;"><b>1</b> white</td> <td style="width: 15%;"><b>3</b> red</td> <td style="width: 15%;"><b>5</b> yellow</td> <td style="width: 15%;"><b>7</b> blue</td> <td style="width: 15%;"><b>9</b> gray</td> </tr> <tr> <td><b>2</b> black</td> <td><b>4</b> orange</td> <td><b>6</b> green</td> <td><b>8</b> brown</td> <td></td> </tr> </table> <p><small>1 White, black &amp; red are standard. Other colors available for quantities of 5K or more.</small></p>	<b>1</b> white	<b>3</b> red	<b>5</b> yellow	<b>7</b> blue	<b>9</b> gray	<b>2</b> black	<b>4</b> orange	<b>6</b> green	<b>8</b> brown						
<b>1</b> white	<b>3</b> red	<b>5</b> yellow	<b>7</b> blue	<b>9</b> gray											
<b>2</b> black	<b>4</b> orange	<b>6</b> green	<b>8</b> brown												

<b>6 TERMINATION</b>	
<b>M1</b> Solder Lug	<b>M5-3</b> Wire Wrap [10.80]
<b>M2</b> PCB	<b>M5-4</b> Wire Wrap [26.97]
<b>M3</b> Quick Connect	<b>M6</b> PC Mount, 90° horizontal
<b>M5-1</b> Wire Wrap .750 [19.05]	<b>M7</b> PC Mount, 90° vertical
<b>M5-2</b> Wire Wrap [24.48]	<b>VS2</b> PC Mount, U bracket, .620 mounting x .460 high

<b>7 CONTACT</b>			
	<i>Material</i>	<i>Terminal Plating</i>	<i>Rating</i>
<b>G</b>	silver <sup>1</sup>	gold over silver <sup>2</sup>	5A@125VAC or 28VDC; 2A @ 250VAC
<b>K</b>	gold <sup>2</sup>	tin-lead <sup>4</sup>	0.4VA max. @20V max (AC/DC)
<b>P</b>	silver <sup>1</sup>	tin-lead <sup>4</sup>	5A@125VAC or 28VDC; 2A @ 250VAC
<b>Q</b>	silver <sup>1</sup>	silver <sup>1</sup>	5A@125VAC or 28VDC; 2A @ 250VAC
<b>R</b>	gold <sup>2</sup>	gold <sup>2</sup>	0.4VA max. @20V max (AC/DC)
NOTE:			
Tin-lead option available with PC type terminations only.			
1 Moveable contact & terminals: copper alloy, silver plate			
2 Moveable contact & terminals: copper alloy with gold plate over nickel plate			
3 Terminals: silver plate with outer layer in gold plating			
4 Outer terminals: copper alloy with tin-lead over nickel plate			

<b>8 EPOXY SEAL</b>
<b>E</b> epoxy seal

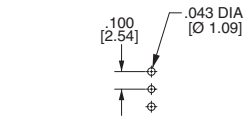
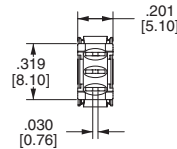
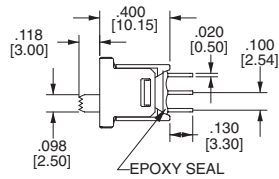
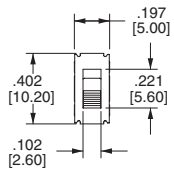
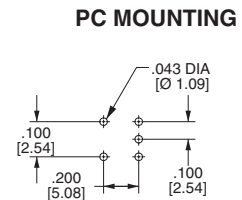
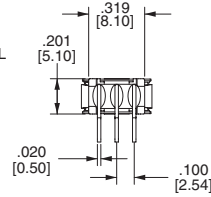
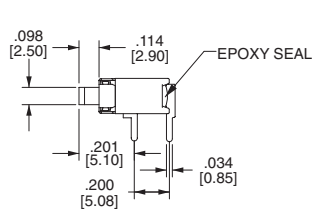
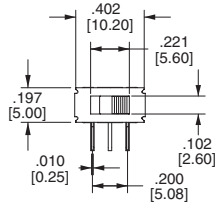
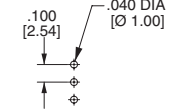
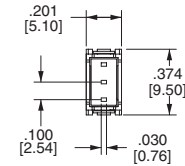
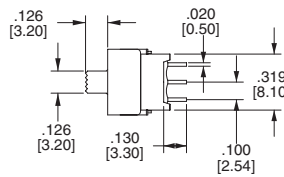
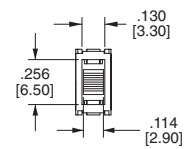
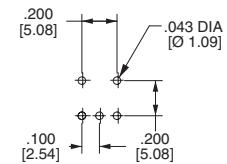
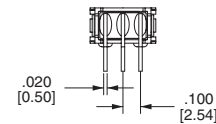
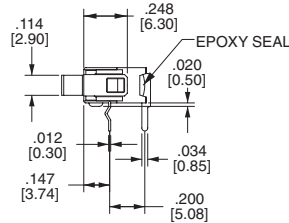
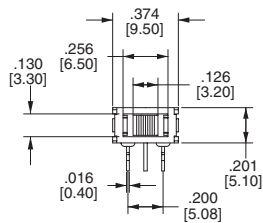
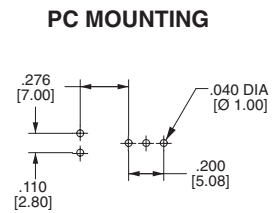
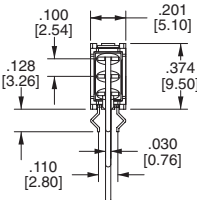
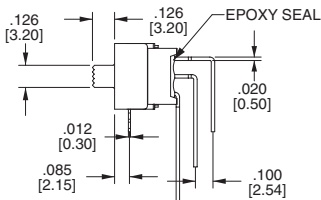
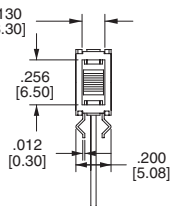
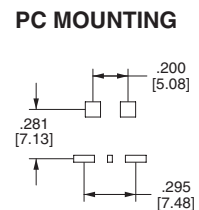
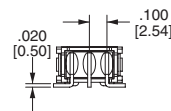
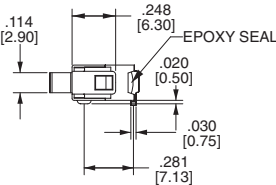
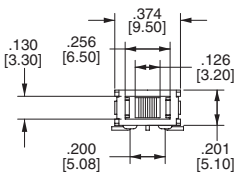
**4S-Series Dimensional Specifications: in. [mm]**
**4S1-Series**
**TERMINATION**
**PC MOUNTING**
**M2**

**M6**

**4SS-Series**
**TERMINATION**
**PC MOUNTING**
**M2**

**M6**

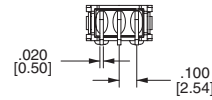
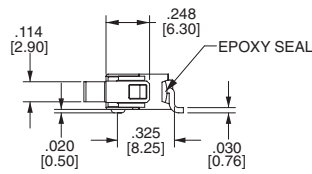
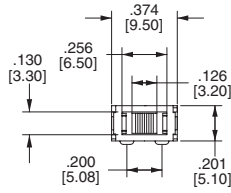
**M7**

**L6**

**4SS-Series Dimensional Specifications: in. [mm]**

**TERMINATION**

**S6**



**PC MOUNTING**

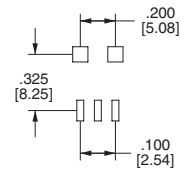

**S7**

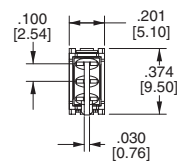
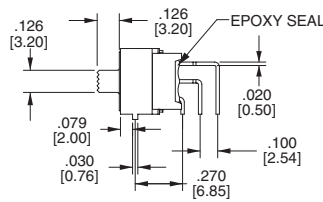
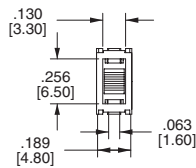

**PC MOUNTING**

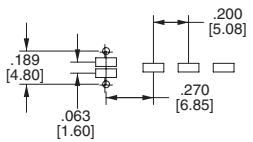

**REEL TAPING**

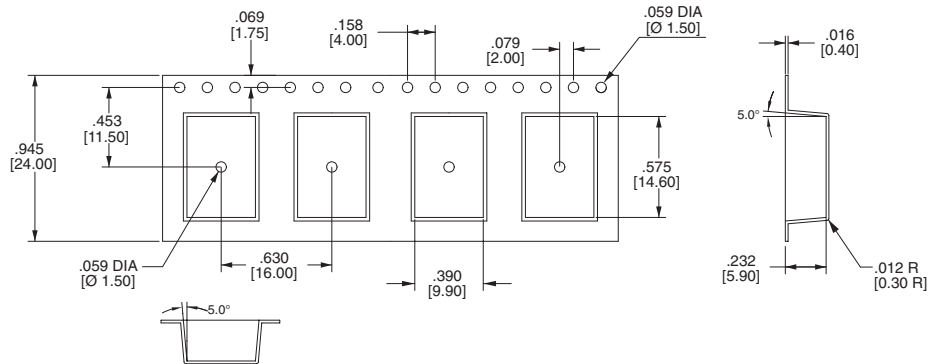

**FOR S6,L6 ONLY**

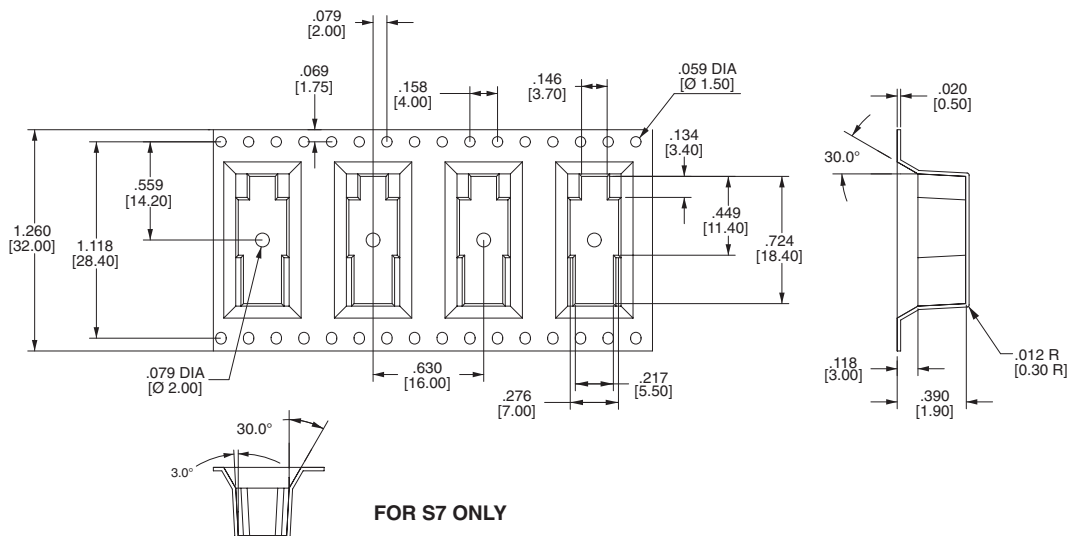

**FOR S7 ONLY**

## 4M1-Series Dimensional Specifications: in. [mm]

### ACTUATOR

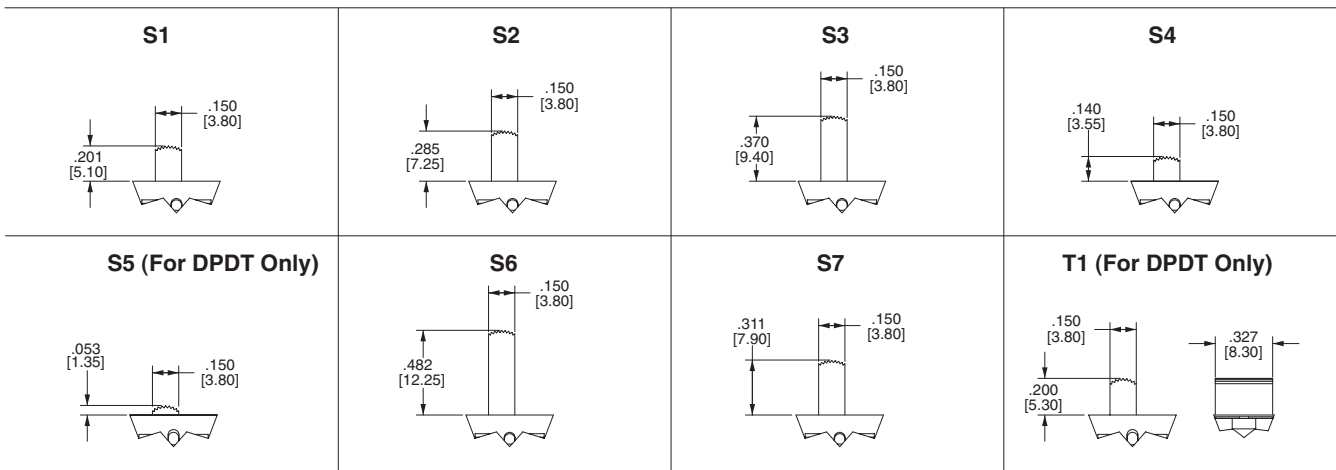

### TERMINATION

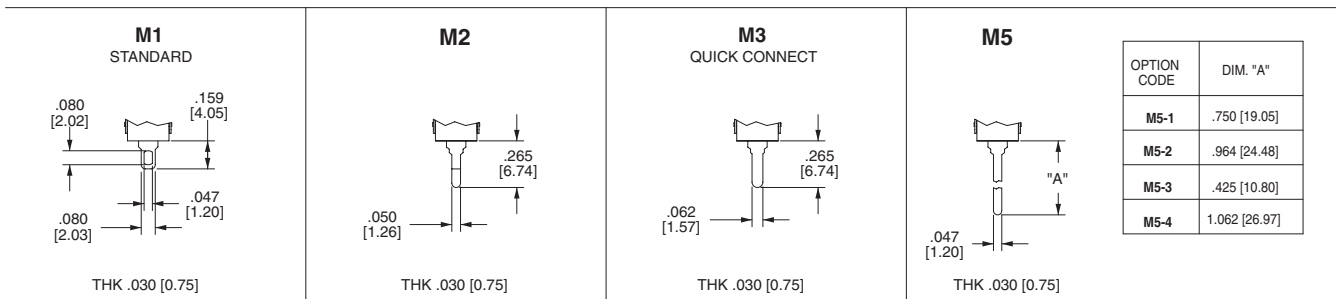

### SINGLE POLE

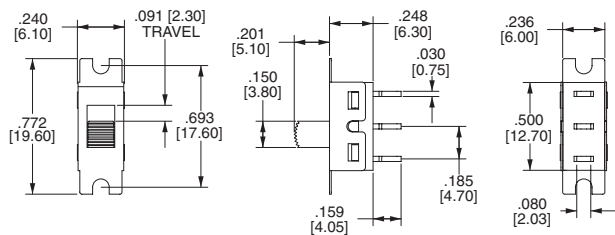

### DOUBLE POLE

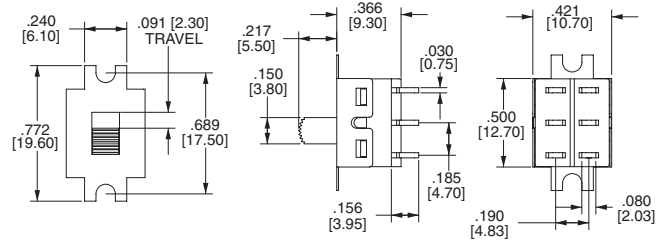

### M6

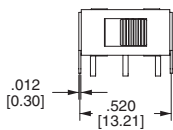

### SINGLE POLE

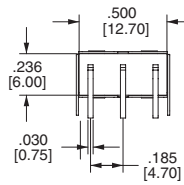
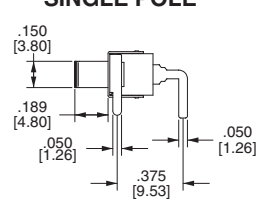

### PC MOUNTING

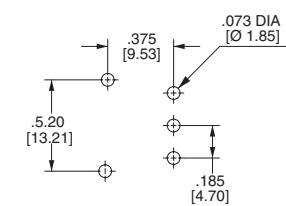

### DOUBLE POLE

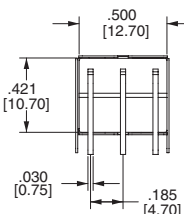
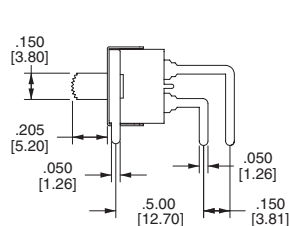

### PC MOUNTING

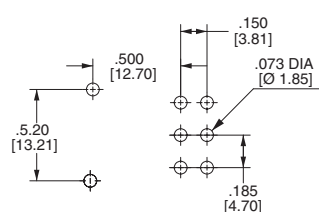

**4M1-Series Dimensional Specifications: in. [mm]**

**TERMINATION**

**M7**

**SINGLE POLE**

**PC MOUNTING**

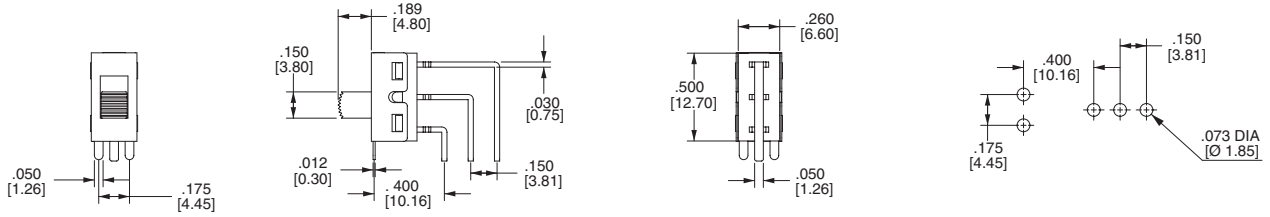

**DOUBLE POLE**

**PC MOUNTING**

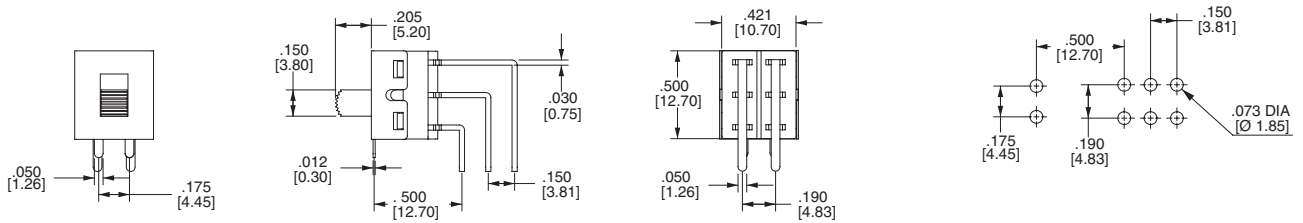

**VS2**

**SINGLE POLE**

**PC MOUNTING**

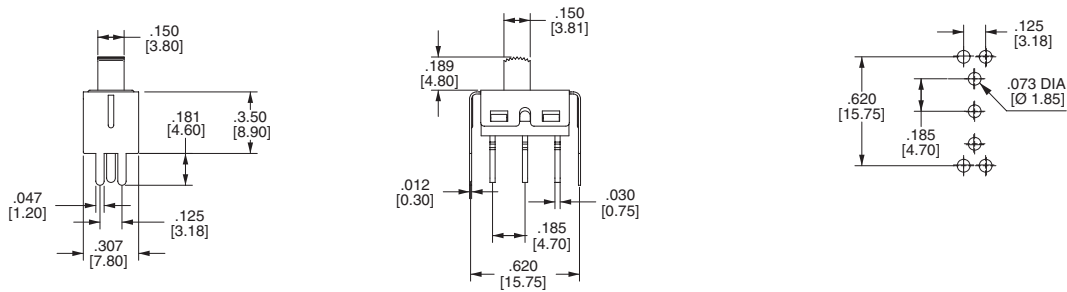

**DOUBLE POLE**

**PC MOUNTING**

